

Part Number: 74101-AE010

Kit Contents

Item #	Quantity Reqd.	Description
1	1	Ashtray
2	1	Installation Manual

Hardware Bag Contents

Item #	Quantity Reqd.	Description
1		
2		
3		

Additional Items Required For Installation

Item #	Quantity Reqd.	Description
1		
2		
3		

Conflicts

--

Recommended Tools

Personal & Vehicle Protection	Notes
None	
Special Tools	Notes
None	
Installation Tools	Notes
None	
Special Chemicals	Notes
None	

Recommended Sequence of Application

Item #	Accessory
1	
2	
3	

*Mandatory







General Applicability

4 Runner	2009
Avalon/HV	2013-
CT200H	2013-
Camry	2011-
Camry Hybrid	2007-
Corolla	2009-
ES300H	2013-
ES350	2010-
FJ Cruiser	2007-
FR-S	2013-
GX460	2010-
Highlander/HV	2008-
LS460	2010-
LS600HL	2010-
Matrix	2009-2013
Prius	2010-
Prius C	2012-
Prius Plug-in	2012-
Rav4	2006-
Rav4 EV	2012-
Sienna	2004-
Venza	2009-
Yaris	2012-
Tundra	2014-

Vehicle Service Parts (may be required for reassembly)

Item #	Quantity Reqd.	Description
1		
2		
3		

Legend

	STOP: Damage to the vehicle may occur. Do not proceed until process has been complied with.
	OPERATOR SAFETY: Use caution to avoid risk of injury.
	CAUTION: A process that must be carefully observed in order to reduce the risk of damage to the accessory/vehicle and to ensure a quality installation.
	TOOLS & EQUIPMENT: Used in Figures calls out the specific tools and equipment recommended for this process.
	REVISION MARK: This mark highlights a change in installation with respect to previous issue.
	SAFETY TORQUE: This mark indicates that torque is related to safety.

Care must be taken when installing this accessory to ensure damage does not occur to the vehicle. The installation of this accessory should follow approved guidelines to ensure a quality installation.

These guidelines can be found in the "Accessory Installation Practices" document.

This document covers such items as:-

- Vehicle Protection (use of covers and blankets, cleaning chemicals, etc.).
- Safety (eye protection, rechecking torque procedure, etc.).
- Vehicle Disassembly/Reassembly (panel removal, part storage, etc.).
- Electrical Component Disassembly/Reassembly (battery disconnection, connector removal, etc.).

Please see your Toyota dealer for a copy of this document.



- ⚠ 1. CAUTION: The Ashtray comes with a rubber jacket. The rubber jacket must be used whenever possible to provide the tightest fit. If the Ashtray cannot fit into the cup holder, remove the rubber jacket and store in a safe place. (Fig. 1-1)**

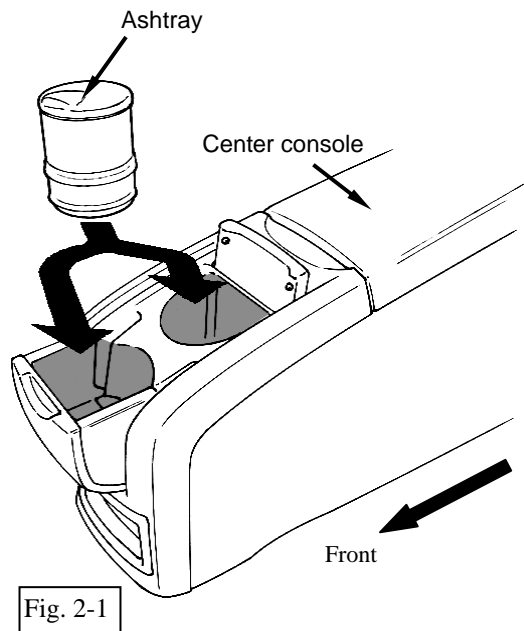

2. Install the Ashtray (Front Console Cup Holder).

- (a) Insert the ashtray into the front cup holder of the center console. (Fig. 2-1)

(1) NOTE: Actual center Console may differ from what is shown.

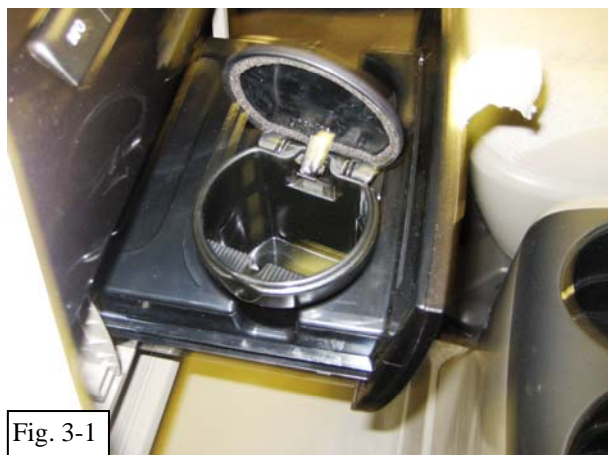

Fig. 3-1

3. Install the Ashtray (Front Tray Cup Holder).

- (a) Insert the ashtray into the front tray cup holder. (Fig. 3-1)

(1) NOTE: Actual Tray may differ from what is shown.

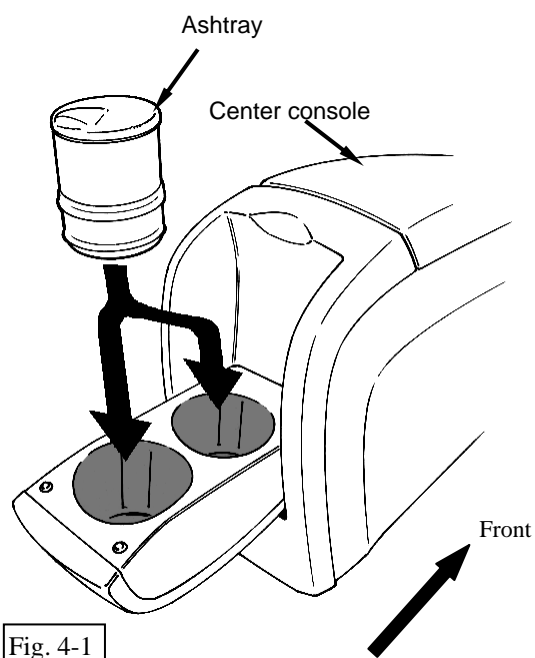









Fig. 4-1

4. Install the Ashtray (Rear Cup Holder).

- (a) Insert the ashtray into the rear cup holder of the center console. (Fig. 4-1)

(1) NOTE: Actual center Console may differ from what is shown.

5. Caution.

-  (a) When not using the ashtray, close the door. While driving, a cigarette butt may drop out of the ashtray if it is left open.
-  (b) Make sure to put a cigarette butt into the ashtray after completely stubbing out the lighted cigarette and close the door. Failure to do so may cause a fire in the vehicle.
-  (c) Never put something inflammable such as wastepaper in the ashtray or a fire may be caused in the vehicle.
-  (d) Never drop the ashtray onto hard ground surface or damage may result.
-  (e) Never apply excessive force to the ashtray door when it is open or damage may result.
-  (f) Remove the ashtray slowly. Removing it quickly may cause a cigarette butt drop out of the ashtray.
-  (g) Open and close a vehicle door with the ashtray door closed. A cigarette butt may drop out of the ashtray if it is left open.

Checklist - these points **MUST** be checked to ensure a quality installation.

<u>Check:</u>	<u>Look For:</u>
<p><u>Accessory Function Checks</u></p> <p><input type="checkbox"/> Ash cup</p>	<p>Installed firmly in cup holder.</p>
<p><u>Vehicle Appearance Check</u></p> <p><input type="checkbox"/> After accessory installation and removal of protective cover(s), perform a visual inspection.</p>	<p>Ensure no damage (including scuffs and scratches) was caused during the installation process. (For PPO installations, refer to TMS Accessory Quality Shipping Standard.)</p>